

Relief Modular Valves

Specifications

Model Numbers	Max. Operating Pressure MPa (PSI)	Max. Flow L/min (U.S.GPM)
MBP-03-* -30 MBA-03-* -30 MBB-03-* -30 MBW-03-* -30	31.5 (4570)	70 (18.5)

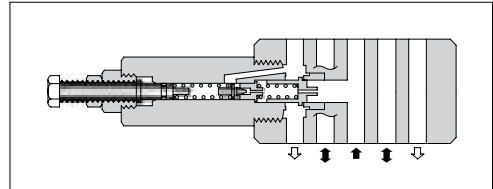

Model Number Designation

F-	MBA	-03	-B	-30	*
Special Seals	Series Number	Valve Size	Pres. Adj. Range MPa (PSI)	Design Number	Design Standard
F: Special Seals for Phosphate Ester Type Fluids (Omit if not required)	MBP : Relief Valve for P-Line MBA : Relief Valve for A-Line MBB : Relief Valve for B-Line MBW : Relief Valve for A&B-Lines	03	B : *-7 ^{★1} (*-1020) H : 3.5-31.5 (510-4570)	30	Refer to ^{★2}

★1. See the "Minimum Adjustment Pressure" of the next page for the item marked *.

★2. Design Standards: None..... Japanese Standard "JIS", European Design Standard and N. American Design Standard

Instructions

- The minimum adjustment pressure equals the value obtained from the minimum adjustment pressure characteristics plus the tank line back pressure of the [next page](#). This back pressure should include the value of the T-line pressure drop characteristics of the valves stacked to the base plate side of the modular valve.
- To make pressure adjustment, loosen the lock nut and turn the pressure adjustment screw clockwise or anti-clockwise. For an increase of pressure, turn the screw clockwise. Be sure to re-tighten the lock nut firmly after making adjustment to the pressure.
- In case of a small flow, the setting pressure may become unstable. To avoid this, refer to the minimum flow characteristic curve of the next page and use the valve within a range as shown with .

Model Numbers	Graphic Symbols	Detailed Graphic Symbols
MBP-03		
MBA-03		
MBB-03		
MBW-03		

Typical Performance Characteristics

Hydraulic Fluid: Viscosity 35 mm²/s (164 SSU), Specific Gravity 0.850

Nominal Override Characteristics

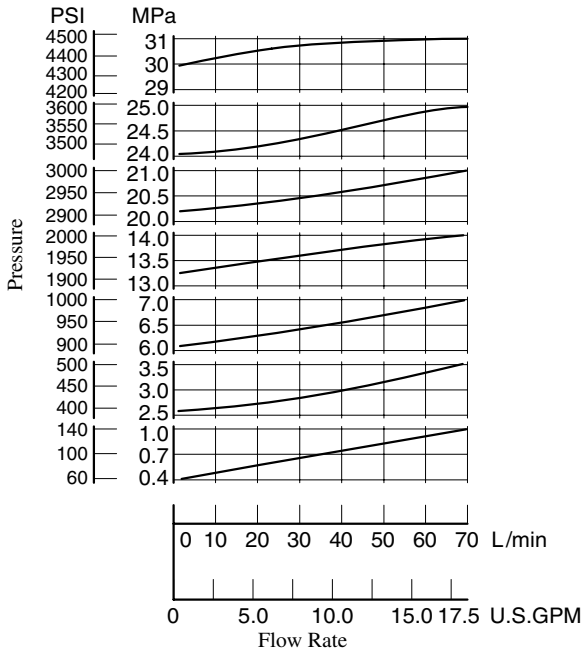

Min. Adjustment Pressure

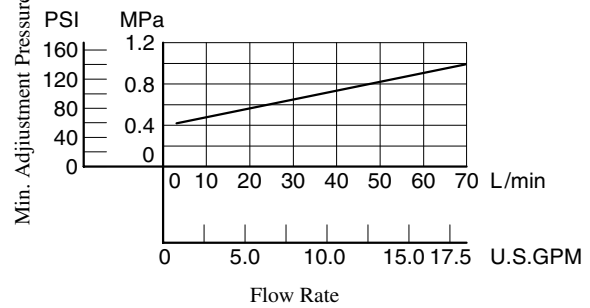

Min. Flow vs. Adjustment Pressure

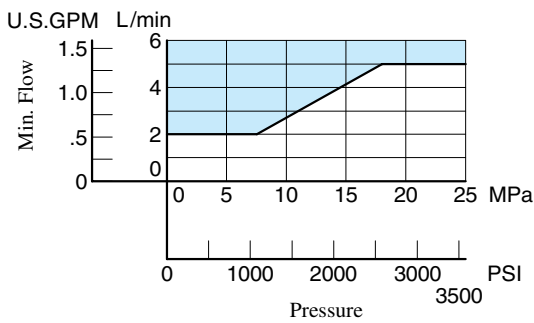

Pressure Drop

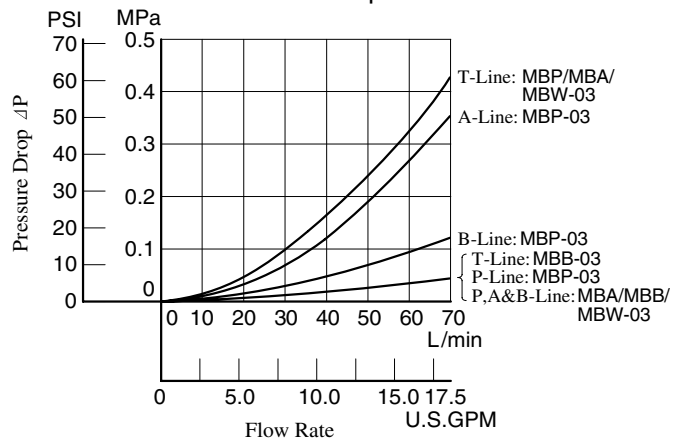

MBW-03-*-30

DIMENSIONS IN MILLIMETRES (INCHES)

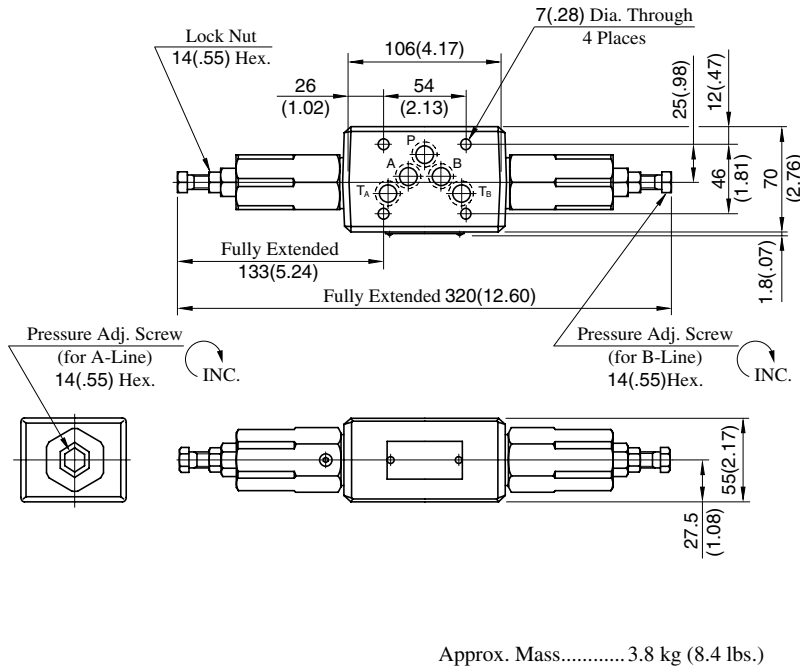

**MBP-03-*-30
MBA-03-*-30**

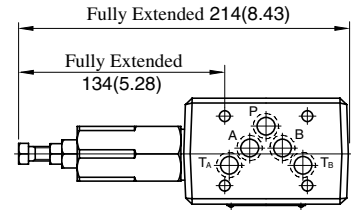

Approx. Mass..... 3.1 kg (6.8 lbs.)

• For other dimensions, refer to "MBW-03" drawing left.

MBB-03-*-30

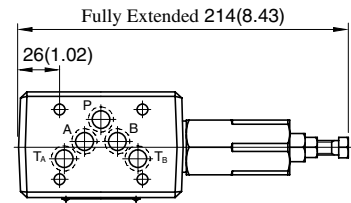

Approx. Mass..... 3.1 kg (6.8 lbs.)

• For other dimensions, refer to "MBW-03" drawing left.

■ Spare Parts List

**MBP-03-*-30
MBA-03-*-30**

MBB-03-*-30

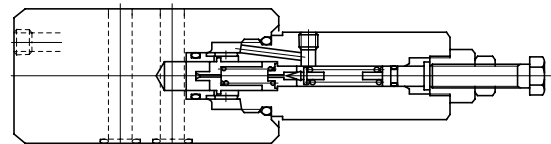
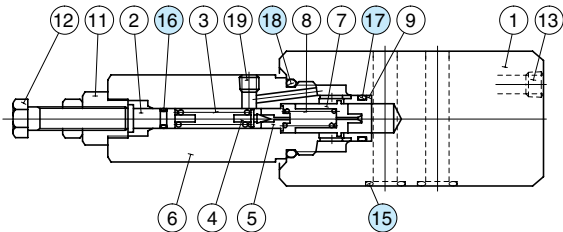

MBW-03-*-30

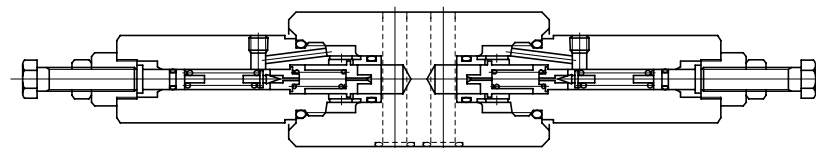

● List of Seals

Item	Name of Parts	Part Numbers	Quantity			
			MBP-03	MBA-03	MBB-03	MBW-03
15	O-Ring	SO-NB-A014	5	5	5	5
16	O-Ring	SO-NA-P6	1	1	1	2
17	O-Ring	SO-NB-P16	1	1	1	2
18	O-Ring	SO-NB-P26	1	1	1	2

Note: When ordering seals, please specify the seal kit number from the table right.

● List of Seal Kits

Valve Model Numbers	Seal kit Numbers
MBP-03	KS-MBP-03-30
MBA-03	
MBB-03	
MBW-03	KS-MBW-03-30